

Installation, Operation and Maintenance Instructions

300 °C Peak Natural Convection Oven - PN Model: 120 Litres
No Controller

PN 120 + No Controller

Contents

This manual is for guidance on the use of the Carbolite Gero product specified on the front cover. This manual should be read thoroughly before unpacking and using the furnace or oven. The model details and serial number are shown on the back of this manual. Use the product for the purpose for which it is intended.

1.0	Symbols and Warnings	4
1.1	Switches and Lights	4
1.2	General Warnings	4
2.0	Installation	6
2.1	Unpacking and Handling	6
2.2	Siting and Setting Up	6
2.2.1	Shelf Fitting	8
2.3	Flat Pack Stand (optional)	10
2.3.1	Parts Supplied	10
2.3.2	Flat Pack Stand Assembly	11
2.4	Electrical Connections	12
3.0	Temperature Controller	14
4.0	Operation	15
4.1	Operating Cycle	15
4.2	Over-Temperature Control (if fitted)	15
4.3	Vents	15
4.4	Temperature Uniformity	16
4.5	Explosive Vapours	16
4.6	Atmospheres	16
4.7	Interior Light (if fitted)	16
4.8	Solenoid Valve with Manual Switch (if fitted)	17
4.9	Exhaust Fan (if fitted)	17
5.0	Maintenance	18
5.1	General Maintenance	18
5.2	Maintenance Schedule	18
5.2.1	Cleaning	20
5.3	Calibration	20
5.4	After-Sales Service	20
5.5	Recommended Spare Parts and Spare Parts Kit	20
5.6	Power Adjustment	20
6.0	Repairs and Replacements	22
6.1	Safety Warning - Disconnection from Power Supply	22

6.2	Safety Warning - Refractory Fibre Insulation	22
6.3	Panel Removal	23
6.4	Temperature Controller Replacement	23
6.5	Solid-State Relay Replacement	23
6.6	Thermocouple Replacement	23
6.7	Element Replacement	24
6.8	Fuse Replacement	24
7.0	Fault Analysis	25
A.	Oven Does Not Heat Up	25
B.	Oven Overheats	25
8.0	Wiring Diagrams	26
8.1	WV-11-00	26
8.2	WV-11-01	27
8.3	WV-11-04	28
9.0	Fuses and Power Settings	29
9.1	Fuses	29
9.2	Power Settings	29
10.0	Specifications	30
10.1	Environment	30

1.0 Symbols and Warnings

1.1 Switches and Lights



Instrument switch: when the instrument switch is operated the temperature control circuit is energised.



Door lock indicator: When this lamp is illuminated, the door is locked and cannot be opened.



Interior light: when the interior light switch is operated the interior light illuminates.



Solenoid valve (if fitted): see section 4.8 for full details



Exhaust fan (if fitted): see section 4.9 for full details

1.2 General Warnings



DANGER – Electric shock. Read any warning printed next to this symbol.

WARNING: Risk of fatal injury.



DANGER – Hot surface. Read any warning printed next to this symbol.

WARNING: All surfaces of a product may be hot.



DANGER – Read any warning printed next to this symbol.



Caution – Double Pole/Neutral Fusing

2.0 Installation

2.1 Unpacking and Handling

Remove the shelves and runners from the packaging before attempting to move the equipment.

When unpacking and handling the product, always lift it by its base. Do not use the door or any other projecting cover or component to support the equipment when moving it. Use two or more people to carry the product where possible.

Carefully remove any packing material from inside and around the product before use. Avoid damaging the surrounding insulation when removing packing materials.

Locate the shelves and runners as required.

2.2 Siting and Setting Up

Place the product on a level surface in a well ventilated area.

Site away from other sources of heat and on a non-flammable surface that is resistant to accidental spillage or hot materials.

The surface on which the equipment is mounted should be stable and not subject to movement or vibrations.

The height of the mounting surface is important to avoid operator strain when loading and unloading samples.

Unless otherwise stated elsewhere in this manual, ensure that there is **at least 150 mm** of free space around the back and sides of the product. Clear space is required above the product to dissipate heat.

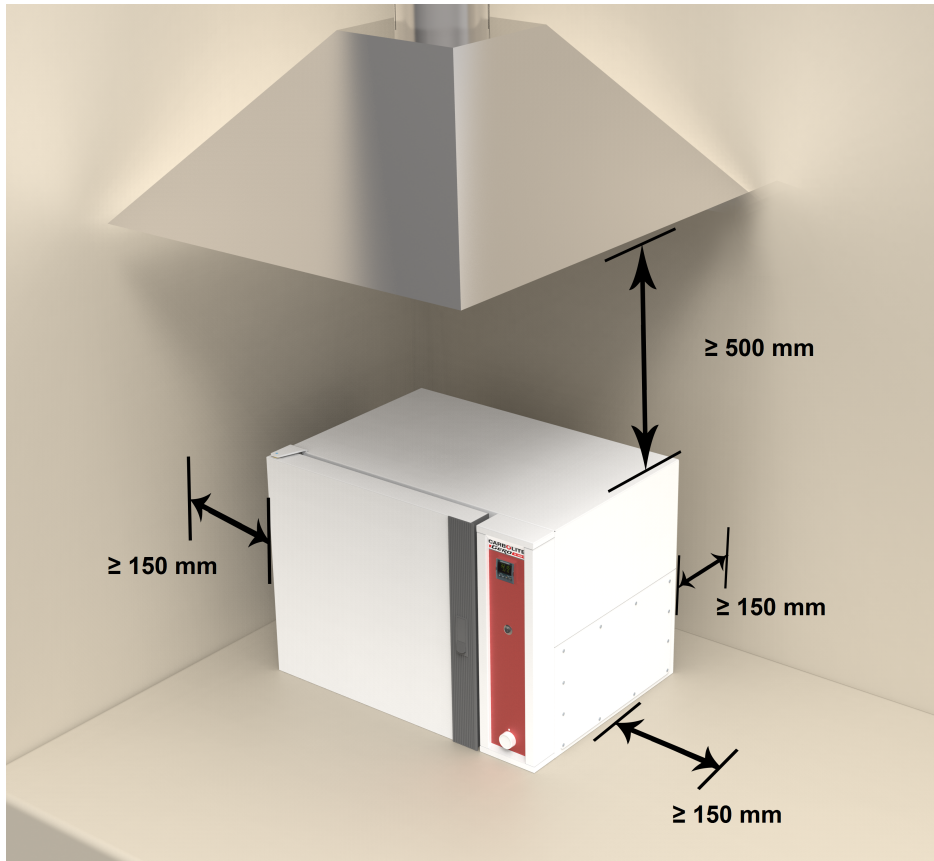

Ensure that the product is placed in such a way that it can be quickly switched off or disconnected from the electrical supply.



Under no circumstances should any objects be placed on top of the product. Always ensure that any vents on the top of the product are clear of any obstruction. Always ensure all cooling vents and cooling fans (if fitted) are clear of any obstruction.

If the over-temperature option is not fitted, ensure that the unit can be directly observed.

2.2.1 Shelf Fitting

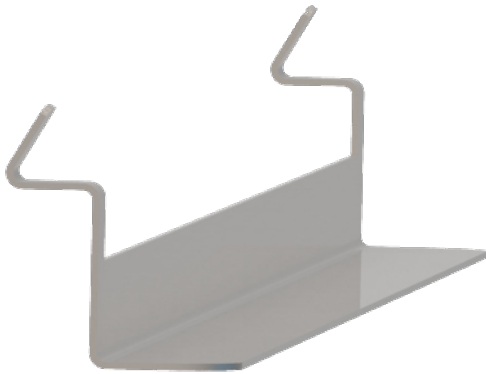

Runner

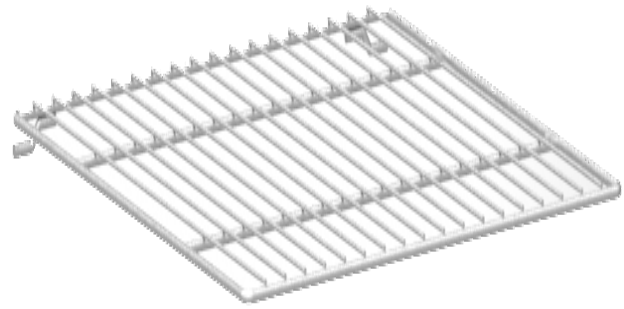

Shelf

To fit the shelves:

1. Insert the runner into the slots in the side of the oven chamber, as shown in figures 1 and 2
2. Rotate the runner downwards by 90° so that the runner hooks into place and creates a level surface upon which the shelf can securely rest, as shown in figures 3 and 4
3. Repeat this process on both sides of the oven chamber
4. Slide the shelves onto the runners so that the spur is positioned on the underside of the runner towards the back of the chamber (see figure 5). This will prevent the shelf from tilting forwards when it is partially withdrawn

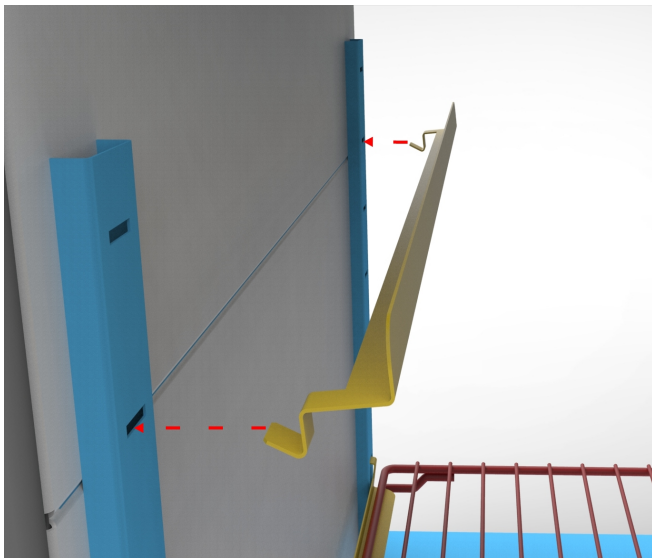

*Figure 1:
Runner*

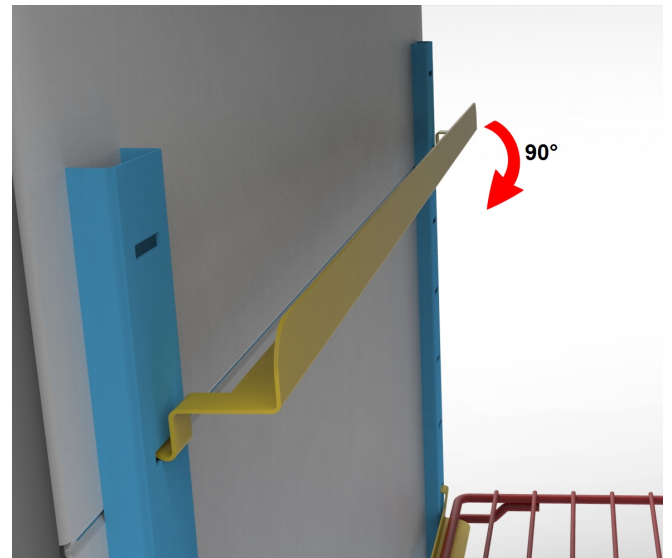

*Figure 2:
Runner inserted into slots in the side of
chamber*

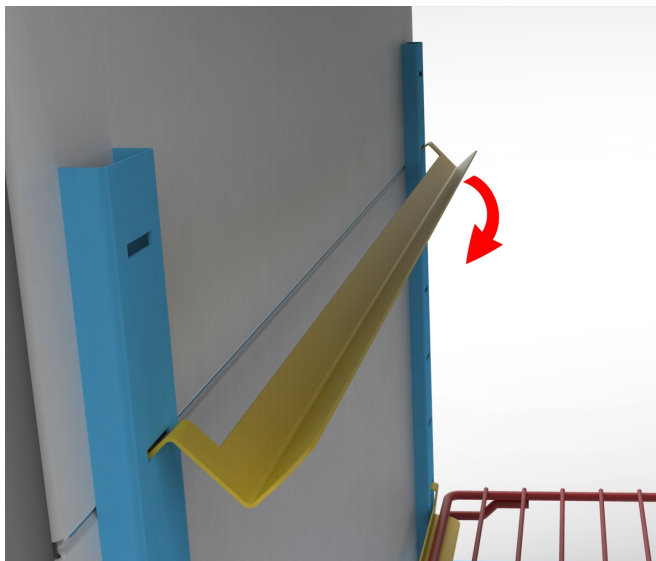

Figure 3:
Rotating runner into position



Figure 4:
Runner in position

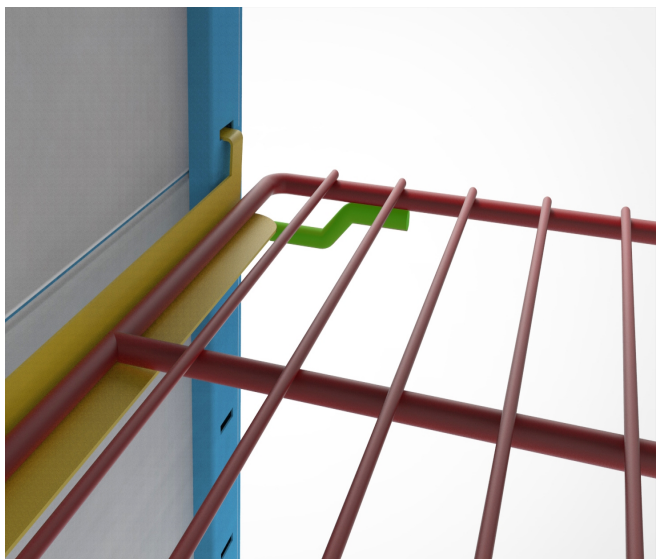

Figure 5:
Shelf resting on runners with spur at rear of chamber
(highlighted in green)

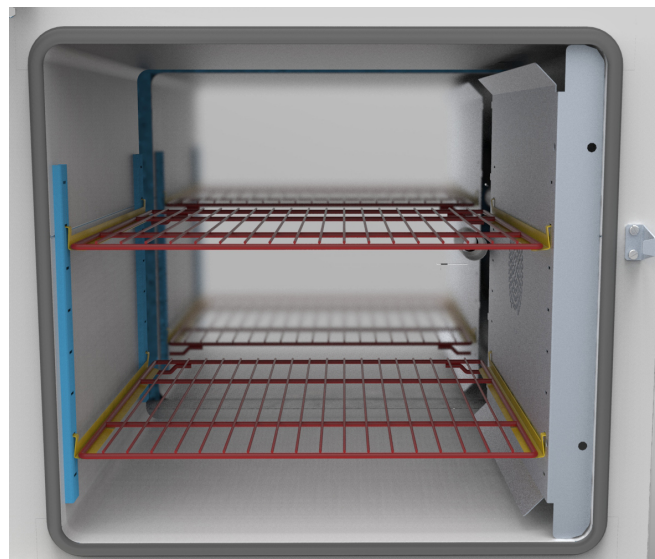
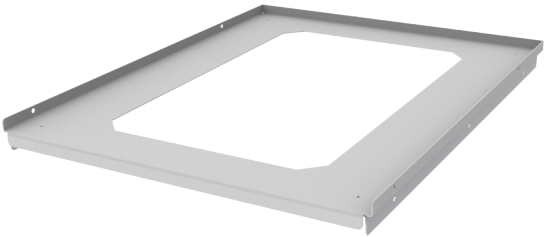

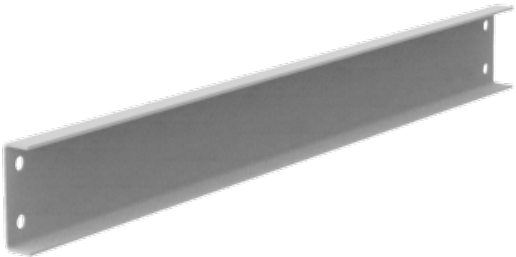
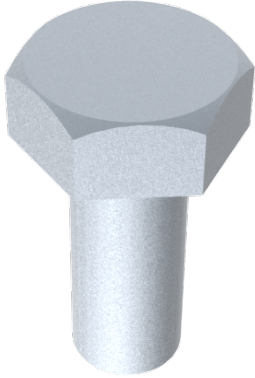
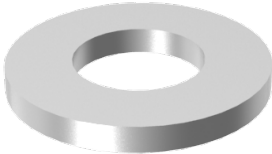



Figure 6:
Shelves fitted

2.3 Flat Pack Stand (optional)

The flat pack stand is available in a range of sizes depending on the dimensions of the product for which it has been ordered. Subsequently, the number of fixings may vary between the different sizes of stand.

2.3.1 Parts Supplied

Stand Top (x1)	Stand Leg (x2)
	
Stand Cross Brace (x2)	M10 Bolt
	
M10 Washer	M10 Locking Nut
	

2.3.2 Flat Pack Stand Assembly

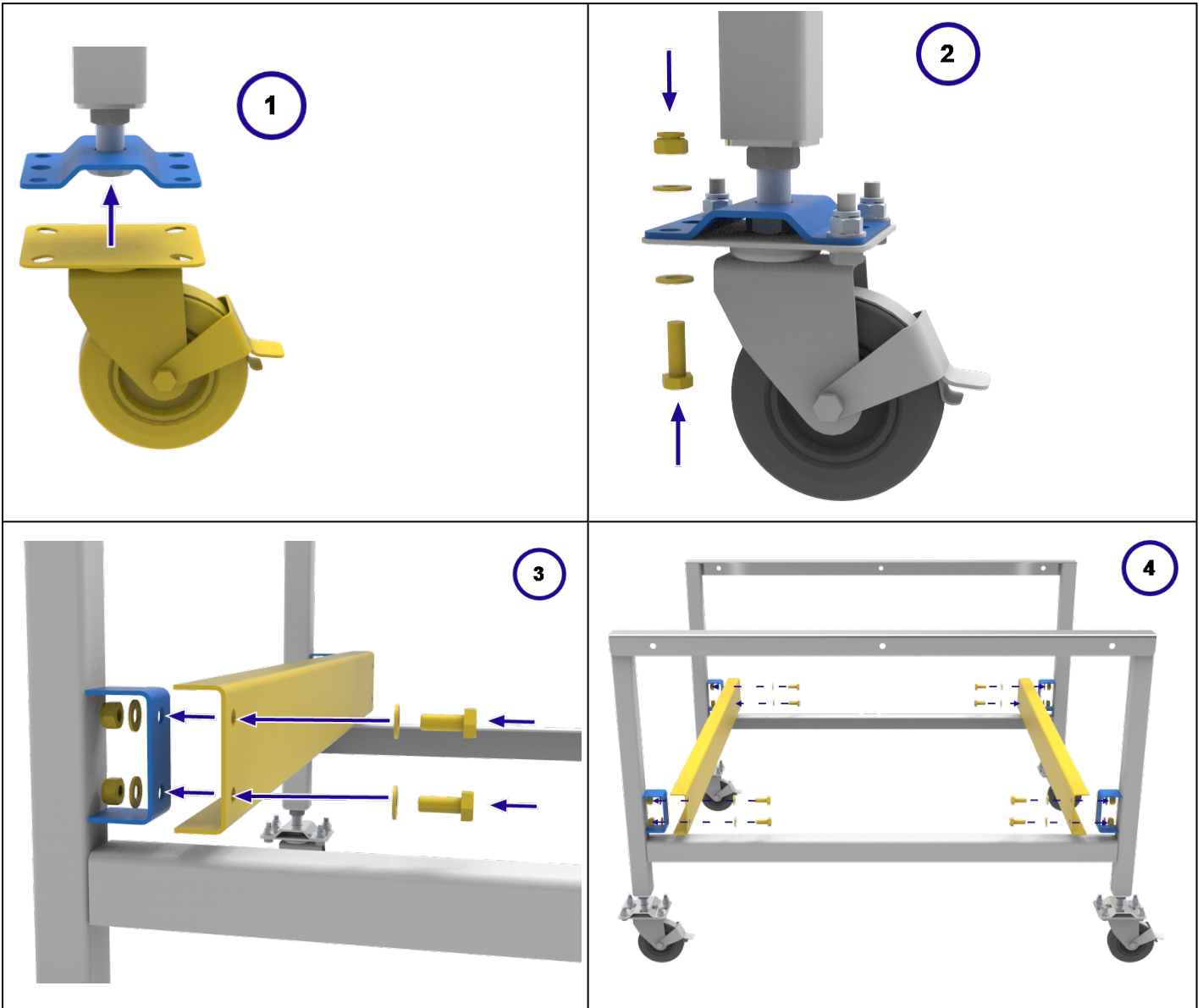

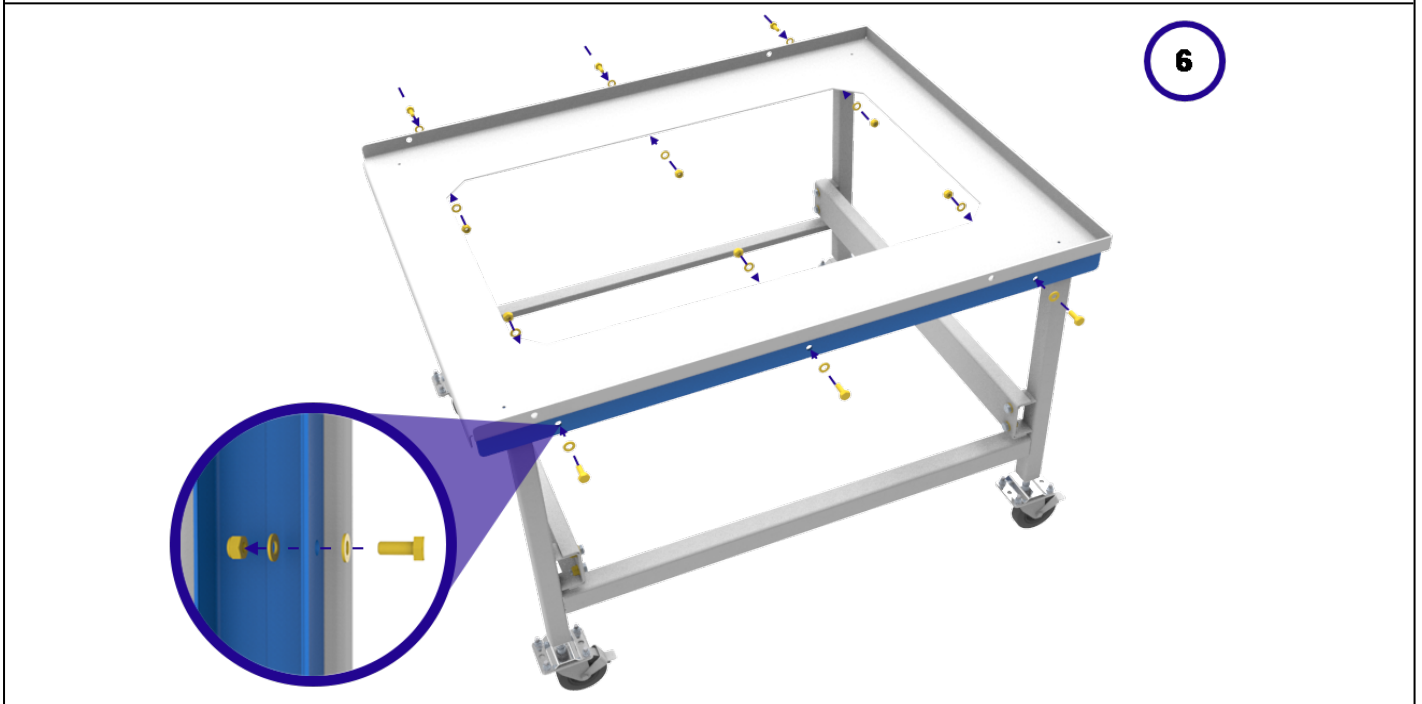
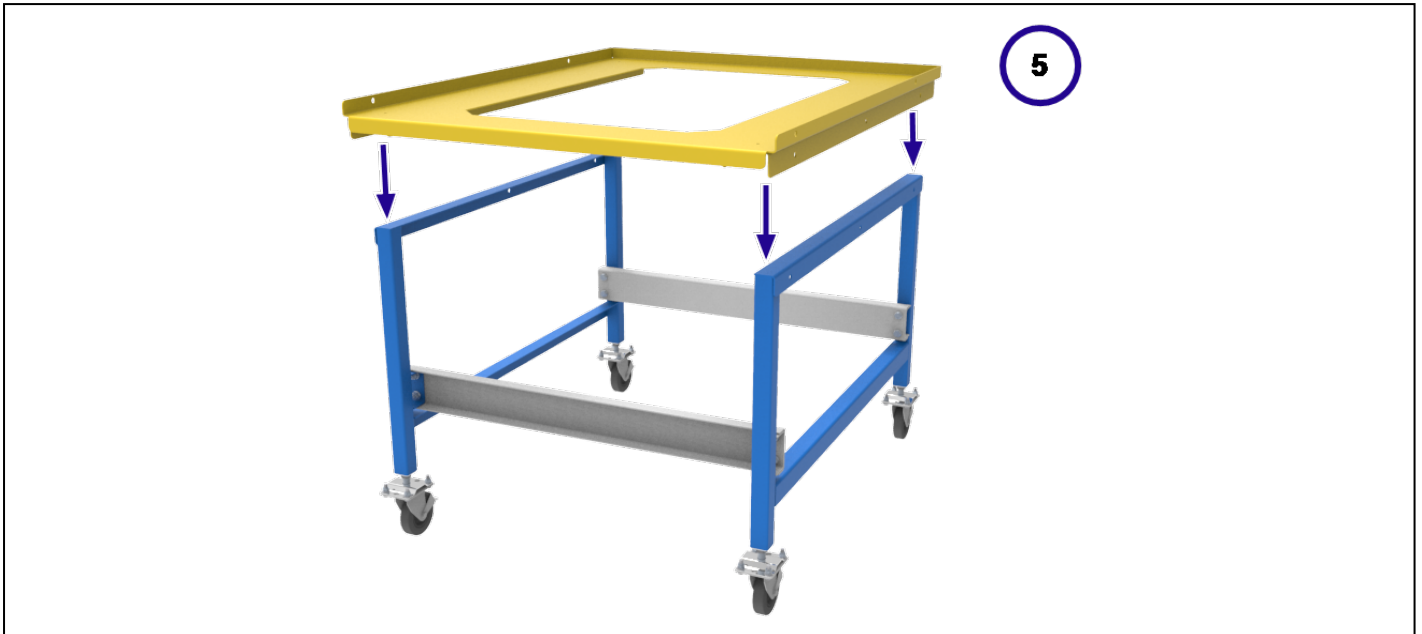

2.4 Electrical Connections



Connection by a qualified electrician is recommended.

All models covered by this manual may be ordered for single phase A.C. supply, which may be Live to Neutral non-reversible, Live to Neutral reversible or Live to Live.

Check the product rating label before connection. The supply voltage should agree with the voltage on the label and the supply capacity should be sufficient for the current on the label.

The supply should be fused at the next size equal to, or higher than the current on the label. This manual contains a table of the most common fuse ratings.

When the mains cable is factory fitted, internal fuses are also fitted. It is essential that the operator ensures that the product is correctly fused.

Products with a factory fitted supply cable are designed to be wired directly to an isolator or fitted with a line plug.

Products without a factory fitted supply cable require a permanent connection to a fused and isolated supply. The product's electrical access panel should be temporarily removed, and connections made to the internal terminals.

When connecting the product to the power supply, the plug or isolating switch should be accessible, easy to remove, and within reach of the operator.

The supply **MUST** incorporate an earth (ground).

Electrical Connection Details:

Supply	Terminal Label	Cable Colour	Supply Types	
			Live - Neutral	Reversible or Live-Live
1-phase	L1	Brown	to live	to either power conductor (For USA 200-240V, connect L1)
	N / L2	Blue	to neutral	to the other power conductor (For USA 200-240V, connect L2)
	PE	Green/ Yellow	to earth (ground)	to earth (ground)

2- or 3-phase	L1	Black	to phase 1
	L2	Black	to phase 2
	L3	Black	to phase 3 (except 2-phase)
	N	Light Blue	to neutral (except delta)
	PE	Green/ Yellow	to earth (ground)

3.0 Temperature Controller

If this product is fitted with a temperature controller, instructions are provided separately.

4.0 Operation

4.1 Operating Cycle

This product is fitted with an instrument switch which cuts off power to the control circuit.

Connect the product to the electrical supply.

Turn on the instrument switch to activate the temperature controllers. The controllers illuminate and go through a short test cycle.

Over-Temperature option only. If the hydraulic thermostat over-temperature option is fitted, set the rotary dial to the desired protection temperature.

Over-Temperature option only. If the digital over-temperature option has not yet been set as required, set and activate it according to the over-temperature controller instructions.

The product will heat up according to the controller setpoint or program, unless a time switch is fitted and switched off.

Over-Temperature option only. If the over-temperature circuit has tripped, an indicator on the over-temperature controller flashes and the heating elements are isolated. Find and correct the cause before resetting the over-temperature controller according to the instructions supplied.

DO NOT switch off if the temperature is above 100 °C - damage could be caused to the fan and motor. Adjust the controller to allow the temperature to fall.

4.2 Over-Temperature Control (if fitted)

The over-temperature controller should typically be set at 15 °C above the main controller. If an over-temperature condition occurs, check the main controller is functioning correctly.

An over-temperature condition cuts off power to the heating elements. A light in the over-temperature controller flashes. To reset this, refer to the over-temperature control section of this manual.

For hydraulic thermostat, the over-temperature trip operates then a click occurs and a warning light near the thermostat lights up; the reset button on the thermostat pops out. Reset by pressing the button. In some models the reset button is directly accessible. In others it is necessary to turn the thermostat dial till the hole lines up with the reset button and press it using a small diameter rod.

For digital, a light in the over-temperature controller flashes. Reset the over-temperature controller according to the over-temperature controller instructions.

4.3 Vents

On the back of this product are two vents: inlet and exhaust. The inlet vent is covered by a baffle that should be left in place.

The exhaust vent is closed by a butterfly valve that can be controlled from the front panel. Rotate the knob clockwise to open the vent, anticlockwise to close.

In non-fan models there is only a small flow of air through the chamber. With fan versions, fumes are pushed out through the exhaust vent by fan action and fresh air is drawn in through the inlet vent.

4.4 Temperature Uniformity

Where accurate temperature control of the load is important, use the central part of the chamber and place or distribute the load to allow free air circulation. Do not place loads on the chamber floor: use the bottom shelf.

4.5 Explosive Vapours



Unless your product includes the stoving and curing option, this model is not suitable for drying or heat treatment applications where vapours are released that are combustible or which can form explosive mixtures with air. Carbolite Gero manufactures other products suitable for these applications.

4.6 Atmospheres

When an optional gas inlet is fitted, there is a label near the inlet saying "INERT GAS ONLY". In practice, inert or oxidising gases may be used, but not combustible or toxic gases.

The chamber is not gas tight, the gas usage may be high and the chamber is always likely to contain some air. Residual oxygen of approximately 1% to 2% is to be expected.

4.7 Interior Light (if fitted)



If fitted, the interior light is operated using the panel mounted switch. It will only operate when the instrument switch is on.

4.8 Solenoid Valve with Manual Switch (if fitted)



If ordered the solenoid valve is operated using the panel mounted switch. When the switch is in the 'ON' position the solenoid valve will allow gas to

flow. Ensure the installation and use of the product does not create a hazardous atmosphere. The workspace must have sufficient ventilation.

4.9 Exhaust Fan (if fitted)



To operate the exhaust fan use the fan switch on the control panel; this is only functional when the instrument switch is on.

The level of air exhaust can be controlled by adjusting the slider under the exhaust box.

When the exhaust fan is turned on, there may be a drop in internal temperature before the product recovers to the setpoint value.

The airflow should be adjusted to the minimum required by the process to reduce the amount of energy wasted in heating air.

5.0 Maintenance

5.1 General Maintenance

Preventive rather than reactive maintenance is recommended. The type and frequency depends on the product use; the following are recommended.















5.2 Maintenance Schedule

 CUSTOMER

 QUALIFIED PERSONNEL



DANGER! ELECTRIC SHOCK. Risk of fatal injury. Only electrically qualified personnel should attempt these maintenance procedures.

Maintenance Procedure	Method	Frequency				
		Daily	Weekly	Monthly	Bi-Annually	Annually
Safety						
Over-Temperature Safety Circuit (if fitted)	Set an over-temperature setpoint lower than the displayed temperature and check for an over-temperature alarm as detailed in this manual					
Over-Temperature Safety Circuit (if fitted)	Electrical measurement 					
Door Seal	Visual inspection - check for splits or fraying					
Door Seal	Replacement					
Air Vent	Check and clean if necessary					
Electrical Safety (external)	Visual check of external cables and plugs					
Electrical Safety (internal)	Physically check all connections and cleaning of the power plate area					
Function						
Temperature Calibration	Tested using certified equipment, frequency dependent on the standard required					
Operational Check	Check that all functions are working normally					
Operational Check	Thorough inspection and report incorporating a test of all functions					

Performance						
Cooling Fans (if fitted)	Check whether the cooling fans are working					
Circulating Fan (if fitted)	Visual check to see if it is running					
Circulating Fan (if fitted)	Check bearings and replace if necessary					
Element Circuit	Electrical measurement					
Power Consumption	Measure the current drawn on each phase / circuit					
Shelves	Visual check for fit and damage					

5.2.1 Cleaning

The product's outer surface may be cleaned with a damp cloth. Do not allow water to enter the interior of the case or chamber. Do not clean with organic solvents.



Under no circumstances should any objects be placed on top of the product. Always ensure that any vents on the top of the product are clear of any obstruction. Always ensure all cooling vents and cooling fans (if fitted) are clear of any obstruction.

5.3 Calibration

After prolonged use, the controller and/or thermocouple may require recalibration. This is important for processes that require accurate temperature readings or for those that use the product close to its maximum temperature. A quick check using an independent thermocouple and temperature indicator should be made from time to time to determine whether full calibration is required. Carbolite Gero can supply these items.

Depending on the controller fitted, the controller instructions may contain calibration instructions.

5.4 After-Sales Service

Carbolite Gero Service has a team of Service Engineers who can offer repair, calibration and preventive maintenance of furnace and oven products both at the Carbolite Gero factory and at customers' premises throughout the world. A telephone call or email often enables a fault to be diagnosed and the necessary parts to be despatched.

In all correspondence please quote the serial number and model type given on the rating label of the product. The serial number and model type are also given on the back of this manual when supplied with the product.

Carbolite Gero Service and Carbolite Gero contact information can be found on the back page of this manual.

5.5 Recommended Spare Parts and Spare Parts Kit

Carbolite Gero can supply individual spare parts or a kit of the items most likely to be required. Ordering a kit in advance can save time in the event of a breakdown.

Each kit consists of a thermocouple, a solid state relay, an instrument switch, an element or set of elements and a door seal; for fan models the kit includes a fan and motor assembly. Individual spare parts are also available.

When ordering spare parts please quote the model details as requested above.

5.6 Power Adjustment

The control system incorporates electronic power limiting, but for the model listed in this manual the power limit is set to 100%. The power limit parameter OP.Hi may be accessible to the operator, but should not generally be altered.

In some cases the supply voltage may be outside the range 220-240 V or the 3-phase equivalent, the power limit parameter may be set to a value other than 100%. Do not increase the value to 100%, see section 9.0 for details of power limit settings.

6.0 Repairs and Replacements

6.1 Safety Warning - Disconnection from Power Supply



Immediately switch the product off in the event of unforeseen circumstances (e.g. large amount of smoke). Allow the product to return to room temperature before inspection.



Always ensure that the product is disconnected from the electrical supply before repair work is carried out.

Caution: Double pole/neutral fusing may be used in this product.

6.2 Safety Warning - Refractory Fibre Insulation



Insulation made from High Temperature Insulation Wool Refractory Ceramic Fibre, better known as (Alumina silicate wool - ASW).

This product contains **alumino silicate wool** products in its thermal insulation. These materials may be in the form of blanket or felt, formed board or shapes, slab or loose fill wool.

Typical use does not result in any significant level of airborne dust from these materials, but much higher levels may be encountered during maintenance or repair.

Whilst there is no evidence of any long term health hazards, it is strongly recommended that safety precautions are taken whenever the materials are handled.

Exposure to fibre dust may cause respiratory disease.

When handling the material, always use approved respiratory protection equipment (RPE-eg. FFP3), eye protection, gloves and long sleeved clothing.

Avoid breaking up waste material. Dispose of waste in sealed containers.

After handling, rinse exposed skin with water before washing gently with soap (not detergent). Wash work clothing separately.

Before commencing any major repairs it is recommended to make reference to the European Association representing the High Temperature Insulation Wool industry (www.ecfia.eu).

Further information can be provided on request. Alternatively, Carbolite Gero Service can quote for any repairs to be carried out either on site or at the Carbolite Gero factory.

6.3 Panel Removal



Disconnect the product from the electrical supply.

Control panel:

Open the door and remove two screws located in recesses on the left side of the control panel (these screws are covered with plastic caps). Lift the panel, pull forward the bottom of the panel and lower the panel to disengage it from the top of the body. Note that the panel remains connected by wiring. Do not disconnect any wiring without first making a careful note of all the connections.

Internal element cover:

Open the door. Side cover (fan models): remove any screws holding the panel. Bottom cover (non-fan): no screws; the panel clips into place. Remove the cover.

6.4 Temperature Controller Replacement

Refer to the controller instructions for more information on how to replace the temperature controller.

6.5 Solid-State Relay Replacement



Disconnect the product from the power supply and remove the appropriate cover as given above.

1. Make a note of the wire connections to the solid state relay, then disconnect them.
2. Remove the solid state relay from the base panel or aluminium plate.
3. Replace and reconnect the solid state relay ensuring that the bottom of it has good thermal contact with the base panel or aluminium plate.
4. Replace the access panel.

6.6 Thermocouple Replacement



Disconnect the product from the power supply. Remove the appropriate panel to gain access to the thermocouple connections. Make a note of the thermocouple connections.

Thermocouple cable colour codings are:

Thermocouple Leg	Colour
positive (type K)	green
negative	white

1. Disconnect the thermocouple to be replaced from its terminal block and withdraw it.
2. Re-assemble the new thermocouple, observing the colour coding.
3. Refit the element access panel.

6.7 Element Replacement

- Remove the control panel and the internal element cover (see section 6.3). The element terminals are located in the side compartment.
- Disconnect the wires from the heating element terminals.
- Remove any starlock washers - these may need to be cut with wire cutters.
- Remove any clips holding the element inside the chamber and withdraw the element.
- Reverse the procedure when fitting the new heating element.
- To find out whether the heating element failure was caused by a fault in the control circuit, operate the product at a low temperature and check that it is functioning correctly.

6.8 Fuse Replacement

Fuses are accessed by removal of the appropriate panel, as described in the 'Panel Removal' section. Depending on the model, supply fuses and control circuit fuses may be mounted in their own holders, or may be on a circuit board that contains an EMC filter. The fuses are marked with their ratings.

Take care not to disconnect the wires leading from the EMC filter without first recording their positions: they must be reconnected to the correct terminals.

7.0 Fault Analysis

A. Oven Does Not Heat Up					
1.	The temperature controller is OFF	▶	No power from supply	▶	Check the fuses in the supply line
2.	The temperature controller is ON	▶	The controller shows a very high temperature or a code such as EEE or --- or S.br	▶	The temperature sensor has broken or has a wiring fault
		▶	The controller shows a low temperature	▶	The SSR could be failing to switch on due to internal failure, faulty logic wiring from the controller, or faulty controller
		▶	There are no lights glowing on the controller	▶	The controller may be faulty or not receiving a supply due to a faulty switch or a wiring fault

B. Oven Overheats					
1.	Oven only heats up when the instrument switch is ON	▶	The controller shows a very high temperature	▶	The controller is faulty
		▶	The controller shows a low temperature	▶	The thermocouple may have been shorted out or may have been moved out of the oven
				▶	The thermocouple may be connected the wrong way round
				▶	The controller may be faulty
2.	Oven heats up when the instrument switch is OFF	▶	The SSR has failed "ON"	▶	Replace the SSR. Check for an accidental wiring fault which could have overloaded the SSR

8.0 Wiring Diagrams

8.1 WV-11-00

Connections below show single phase with instrument switch(es).

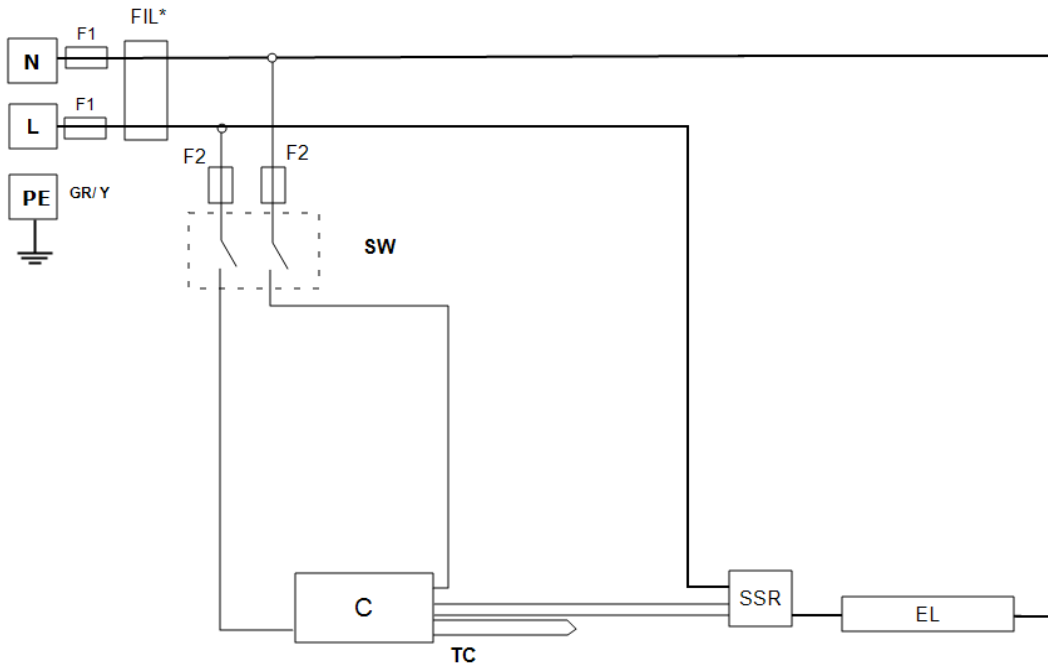

Key	
F1, F2	Fuses
FIL	Filter
SW	Instrument Switch
C	Temperature Controller
TC	Thermocouple
SSR	Solid State Relay
EL	Element(s)
*	If Fitted
L	Live
N	Neutral
PE (GR/Y)	Earth (Green+Yellow)

8.2 WV-11-01

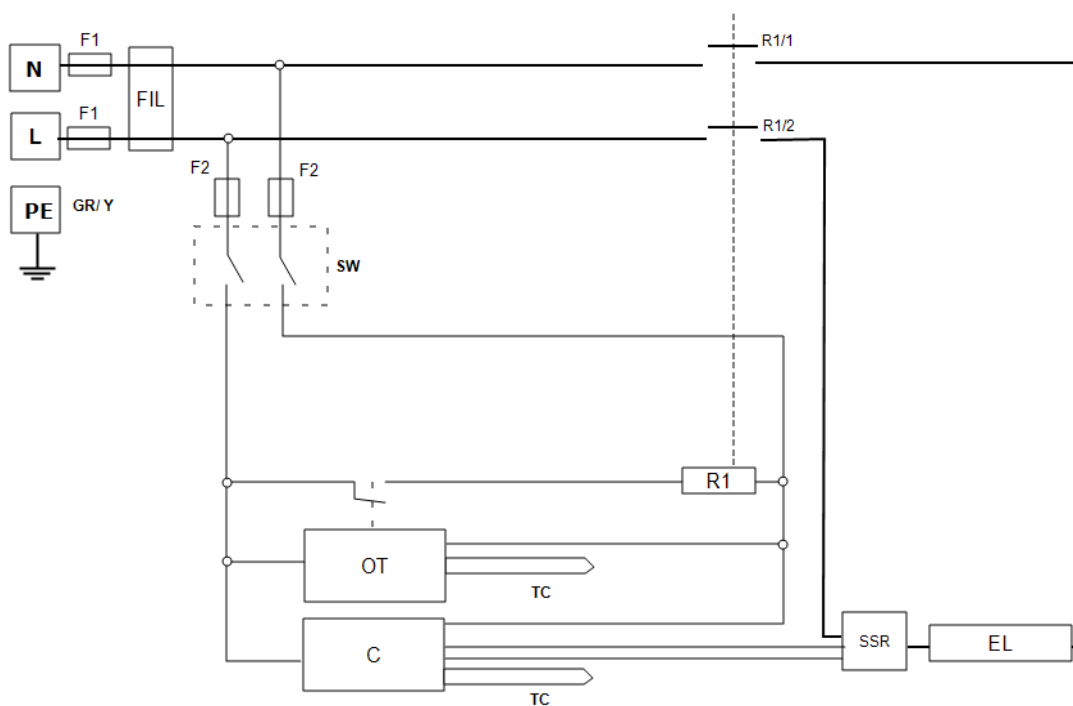

Key	
F1, F2	Fuses
FIL	Filter
SW	Instrument Switch
R1	Relay (Coil)
R1/1, R1/2	Relay Contactor
C	Temperature Controller
OT	Over-Temperature Controller
TC	Thermocouple
SSR	Solid State Relay
EL	Element(s)
*	If Fitted
L	Live
N	Neutral
PE (GR/Y)	Earth (Green+Yellow)

8.3 WV-11-04

Connections below show single phase with hydraulic thermostat.

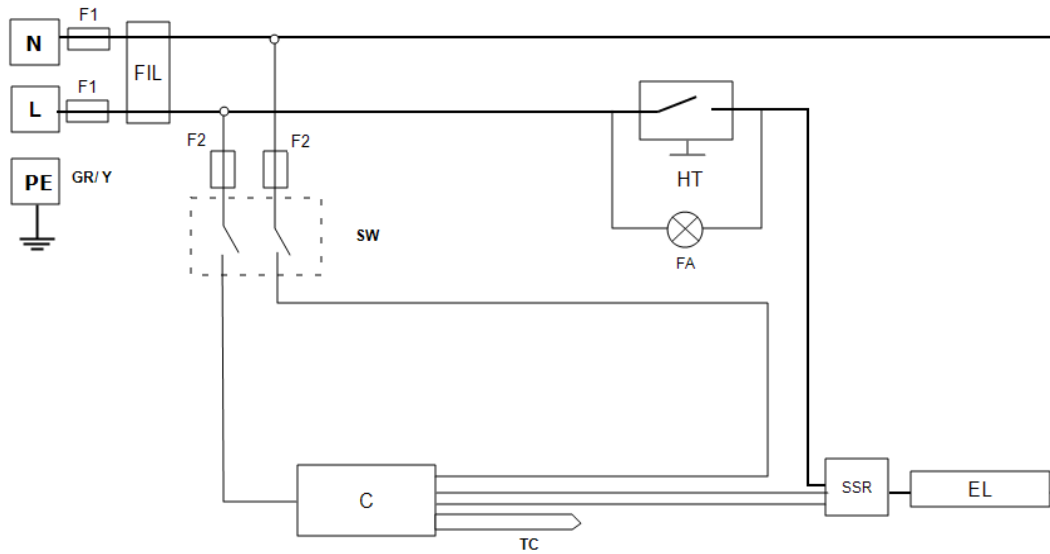

Key	
F1, F2	Fuses
FIL	Filter
SW	Instrument Switch
C	Temperature Controller
TC	Thermocouple
HT	Hydraulic Thermostat
FA	Fault Light
SSR	Solid State Relay
EL	Element(s)
*	If Fitted
L	Live
N	Neutral
PE (GR/Y)	Earth (Green+Yellow)

Note on Hydraulic Thermostat: When used over 16 Amps or in a 2- or 3-phase model, the product is fitted with a contactor; with the hydraulic thermostat in the coil circuit - similar to "WV-11-01".

9.0 Fuses and Power Settings

9.1 Fuses

F1-F2: Refer to the circuit diagrams.

F1	Internal Supply Fuses	Fitted if supply cable fitted. Fitted on board to some types of EMC filter.	38 mm x 10 mm type F fitted on EMC filter circuit board(s)
F2	Auxiliary Circuit Fuses	Fitted on board to some types of EMC filter. May be omitted up to 25 Amp/phase supply rating.	2 Amps glass type F On board: 20 mm x 5 mm Other: 32 mm x 6 mm
	Customer Fuses	Required if no supply cable fitted. Recommended if cable fitted.	See rating label for current; See table below for fuse rating.

Model	Phases	Volts	Supply Fuse	Control Fuse
PN 120	1-phase	110-120 V	16 A	2 A
PN 120	1-phase	220-240 V	V10 A	2 A



208 V models may have a higher fuse rating: check the rating label.
 Stoving and Curing (and possibly moisture extraction option) models may have a higher fuse rating: check the rating label.

9.2 Power Settings

The power limit settings (parameter OP.Hi) for this model are voltage dependant. The figures represent the maximum percentage of time that controlled power is supplied to the elements. Do not attempt to "improve performance" by setting a value higher than the recommended values. To adjust the parameter refer to the "Changing the Maximum Output Power" of the control section of the manual.

Voltage	110 V	120 V	220 V	230 V	240 V
Power (%)	-	100	100	100	100

Please refer to the rating label for product specific information.

10.0 Specifications

Carbolite Gero reserves the right to change the specification without notice.

Model	Max Temp (°C)	Max Power (kW)	Chamber Size (mm)			Approx Capacity (l)	Net Weight (kg)
			H	W	D		
Peak Range Ovens - no fans							
PN 120	300	1.5	450	490	520	115	65

10.1 Environment

The models listed in this manual contain electrical parts and should be stored and used in indoor conditions as follows:

Temperature: 5 °C - 40 °C

Relative humidity: Maximum 80 % up to 31 °C decreasing linearly to 50 % at 40 °C

ProductLabel

The products covered in this manual are only a small part of the wide range of ovens, chamber furnaces and tube furnaces manufactured by Carbolite Gero for laboratory and industrial use. For further details of our standard or custom built products please contact us at the address below, or ask your nearest stockist.

For preventive maintenance, repair and calibration of all furnace and oven products, please contact:

Carbolite Gero Service

Telephone: + 44 (0) 1433 624242

Fax: +44 (0) 1433 624243

Email: ServiceUK@carbolite-gero.com

Carbolite Gero Ltd,

Parsons Lane, Hope, Hope Valley,
S33 6RB, England.

Telephone: + 44 (0) 1433 620011

Fax: + 44 (0) 1433 621198

Email: Info@carbolite-gero.com

www.carbolite-gero.com

CARBOLITE
GERO 30-3000°C

Copyright © 2023 Carbolite Gero Limited