

Installation, Operation and Maintenance Instructions 1700°C Chamber Furnace - HTF Model: 5 Litres No Controller

HTF 17/5 + No Controller

Contents

This manual is for guidance on the use of the Carbolite Gero product specified on the front cover. This manual should be read thoroughly before unpacking and using the furnace or oven. The model details and serial number are shown on the back of this manual. Use the product for the purpose for which it is intended.

1.0	Symbols and Warnings	4
1.1	Switches and Lights	4
1.2	Warning Symbols	4
2.0	Installation	6
2.1	Unpacking and Handling	6
2.2	Siting and Setting Up	6
2.3	Fitting the Heating Elements	7
2.4	Electrical Connections	8
2.5	Power Supply Notes	9
3.0	Temperature Controller	11
4.0	Operation	12
4.1	Operating Cycle	12
4.2	Operator Safety	12
4.3	Loading The Furnace	13
4.4	Opening the Door	13
4.5	Insulation Cracking	13
4.6	Atmospheres & Corrosive Materials	13
4.7	Pesting	14
4.8	Explosive Materials	14
4.9	Notes on Temperature Control	14
4.10	Thermocouple Warnings	15
4.11	Thermal Cutouts	15
4.12	General Operating Advice	16
5.0	Maintenance	17
5.1	General Maintenance	17
5.2	Maintenance Schedule	17
5.2.1	Cleaning	19
5.3	Safety Switch	19
5.3.1	Other Electrical Components	19
5.3.2	Element Glaze	20
5.4	Calibration	20
5.5	After-Sales Service	20
5.6	Recommended Spare Parts and Spare Parts Kit	20

5.7	Power Adjustment (Controller)	20
5.8	Power Adjustment (Thyristor)	21
5.9	Low Voltage Compensation	21
6.0	Repairs and Replacements	22
6.1	Safety Warning - Disconnection from Power Supply	22
6.2	Safety Warning - Refractory Fibre Insulation	22
6.3	Safety Warning - Molybdenum Disilicide Elements	23
6.4	Side Panel Removal	23
6.5	Thyristor Replacement and Adjustment	23
6.6	Temperature Controller Replacement	24
6.7	Fuse Replacement	24
6.8	Thermocouple Replacement	24
6.9	Element Installation and Replacement	24
6.10	Insulation Replacement	27
6.11	Transformer Tappings	27
6.12	Fuse Replacement	28
7.0	Fault Analysis	30
A.	Furnace Does Not Heat Up	30
B.	Product Overheats	31
8.0	Wiring Diagrams	32
8.1	Single Phase 208 V, 220-240 V	32
9.0	Fuses and Power Settings	34
9.1	Fuses	34
9.2	Power Settings	34
10.0	Specifications	35
10.1	Environment	35

1.0 Symbols and Warnings

1.1 Switches and Lights



Instrument switch: when the instrument switch is operated the temperature control circuit is energised.



Heat light: the adjacent light glows or flashes to indicate that power is being supplied to the elements.

1.2 Warning Symbols



DANGER – Electric shock. Read any warning printed next to this symbol.

WARNING: Risk of fatal injury.



DANGER – Hot surface. Read any warning printed next to this symbol.

WARNING: All surfaces of a product may be hot.



DANGER – Read any warning printed next to this symbol.

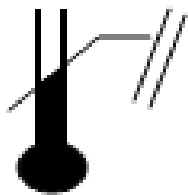

FAULT - read any information printed by this symbol.

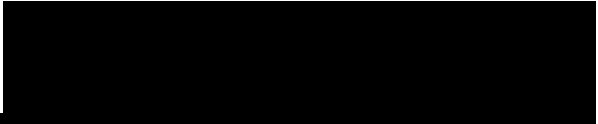

Caution – Double Pole/Neutral Fusing

2.0 Installation

2.1 Unpacking and Handling

When unpacking or moving the product always lift it by its base. Do not use the door or any other protruding parts. The product contains a transformer and is heavy: use two or more people to carry the product.

Remove any packing material from the door gasket and from inside the product chamber. Close the door with care to prevent any damage to insulation surfaces.



NOTE: This product contains Refractory Ceramic Fibre (also known as Alumino Silicate Wool - ASW). For precautions and advice on handling this material see section 6.2.

2.2 Siting and Setting Up

Place the product on a level surface in a well ventilated area.

Site away from other sources of heat and on a non-flammable surface that is resistant to accidental spillage or hot materials.

The surface on which the equipment is mounted should be stable and not subject to movement or vibrations.

The height of the mounting surface is important to avoid operator strain when loading and unloading samples.

Unless otherwise stated elsewhere in this manual, ensure that there is **at least 150 mm** of free space around the back and sides of the product. Clear space is required above the product to dissipate heat.



If the product is to be used in a process which could liberate hazardous gases, then it should be installed together with a suitable fume extraction system.

Ensure that the product is placed in such a way that it can be quickly switched off or disconnected from the electrical supply.



Under no circumstances should any objects be placed on top of the product. Always ensure that any vents on the top of the product are clear of any obstruction. Always ensure all cooling vents and cooling fans (if fitted) are clear of any obstruction.

2.3 Fitting the Heating Elements



Please refer to the Element Installation and Replacement in section 6.0. Wear eye protection when handling the heating elements.

The molybdenum disilicide elements are **EXCEPTIONALLY FRAGILE** and are packed separately, together with other items shown in the list.

Separately Packed Items	1700 °C Models
Elements	4
Element Clamps	8
Element Clips	8
Braids	1 set of 5
Separators/ Block	4
Chimney Unit	1

The installation of these elements is described in section 6.9

2.4 Electrical Connections



Connection by a qualified electrician is recommended.

These models are designed only for single phase electrical supplies, or for two live phases and neutral of a 3-phase supply. The product must be connected only to the type and voltage of supply for which it was ordered.

Check that the supply voltage is compatible with the voltage on the label, and that the current capacity is sufficient for the current on the label, before connection to the electrical supply. A table of the most common ratings is given in section 9.0 towards the back of this manual.

Normally a supply cable is not fitted, and connection is to be made to terminal blocks accessed by removal of the left-hand end side cover (see section 6.4). The electrical supply cable must be properly connected and fitted with an appropriate strain relief at the entry to the case.

The electrical supply cable should be wired to an isolator or fitted with a line plug. The isolator must be within easy reach of the operator, or the line plug must be easily removable and on a lead not exceeding 3 m length. The line plug must allow the protective earth (ground) to be connected before the supply conductors and to be disconnected after them. The supply point must be marked as the disconnecting device for the furnace.

The electrical supply **MUST** incorporate an earth (ground).

Electrical Connection Details:

Supply	Terminal Label	Cable Colour	Supply Types	
			Live - Neutral	Reversible or Live-Live
1-phase	L1	Brown	to live	to either power conductor (For USA 200-240V, connect L1)
	N / L2	Blue	to neutral	to the other power conductor (For USA 200-240V, connect L2)
	PE	Green/ Yellow	to earth (ground)	to earth (ground)
2-phase	L1	Black	to phase 1	
	L2	Black	to phase 2	
	N	Light Blue	to neutral	
	PE	Green/ Yellow	to earth (ground)	

2.5 Power Supply Notes

Each model is manufactured for one of the following voltage ranges:

- 208 V
- 220 to 240 V
- 380 to 415 V (not HTF 17/5 or HTF 18/4)

It is not possible to modify and use a furnace manufactured for the 380-415 range on either of the other two voltage ranges listed above: there are too many component differences.

It is possible to modify a furnace manufactured for either 208 and 220-240, provided the thyristor unit is replaced. A transformer tapping must also be altered. See sections 6.5 and 6.11.

It is possible to alter the voltage within any of the ranges above, by reconnecting the incoming cable to the transformer to the appropriate primary tapping. The tappings are 208 - 220 - 230 - 240 V, or 380 - 400 - 415 V, and are labelled on the primary side of the transformer - see section 6.11. It is also necessary to adjust the setting of the thyristor stack: see section 6.5.

Examples:

- to alter a furnace made for a 240 V supply to 208 V: replace thyristor stack, move a cable to the 208 V transformer tapping, and adjust the thyristor stack.
- to change from a supply of 220 V to 230 V: move a cable to the 230 V, and adjust the thyristor stack.

Please contract Carbolite Gero Service for guidance and assistance if the power supply shown on the rating label does not match the power supply available.

3.0 Temperature Controller

If this product is fitted with a temperature controller, instructions are provided separately.

4.0 Operation

4.1 Operating Cycle

The product is fitted with an instrument switch. The switch cuts off power to the controllers and contactor.

Connect the product to the electrical supply. The cooling fans will operate.

Turn on the instrument switch to activate the temperature controllers. The controllers illuminate and go through a short test cycle.

Over-Temperature option only. If the digital over-temperature option has not yet been set as required, set and activate it according to the over-temperature controller instructions.

The product will heat up according to the controller setpoint or program, unless a time switch is fitted and switched off.

The heat light glows brightly at first, more dimly as the product temperature approaches a program setpoint.

Over-Temperature option only. If the over-temperature circuit has tripped, an indicator on the over-temperature controller flashes and the heating elements are isolated. Find and correct the cause before resetting the over-temperature controller according to the instructions supplied.

To switch the product off, turn the instrument switch off. The case cooling fans continue to operate. Leave the fans on until the product cools to below 300 °C. If the product is to be left unattended, isolate it from the electrical supply.

4.2 Operator Safety



This product incorporates a safety switch which interrupts the heating element circuit when the furnace is opened. This prevents the operator touching a live heating element and also prevents the product from heating up if the furnace is left open. The operation of this switch should be checked periodically.



Depending on use, the surfaces in the working chamber and the chamber load may still be very hot after the appliance is switched off. Touching these surfaces may cause burns. Use suitable personal protective equipment or wait until the appliance cools down to ambient temperature.

Before removing a hot object from the product, make sure there is a safe place to put it down. If necessary use tongs, face masks and heat resistant gloves. Heat resistant clothing and face protection can guard against the effects of radiated heat when the furnace is open.

When the product is opened during operation there is considerable radiated heat. Do not keep any flammable objects near the product, nor objects which could be damaged by radiated heat.

4.3 Loading The Furnace

When heating large objects, in particular poor conductors, avoid shielding the thermocouple from the heating elements. Also ensure that nothing is within 15 mm of the elements.

The thermocouple is intended to sense the temperature near the heating element. However if a large object is placed in the chamber it may record the average temperature of the object and the elements, which can lead to over heating of the elements. Allow large objects to gain heat at a lower temperature and then reset the controller to a temperature close to the desired maximum.

Take care that nothing hits the elements when loading and unloading.

4.4 Opening the Door



Take great care when loading or unloading the furnace chamber. See section 4.2. Before removing a hot object from the furnace, ensure a suitable surface is available on which to put it.

Do not open the door at high temperatures. If possible, do not open it above 200 °C. If it is necessary to load or unload work at elevated temperatures, keep the door open for as short a period as possible. The insulation cools quickly and may crack through thermal shock.

The heating elements and the insulation are very susceptible to mechanical shock. At all times operate the door gently to avoid mechanical shock.

Opening the door when the furnace is very hot can cause hot air to be sucked by the case cooling fans towards the thermal cut out and activate it (see section 4.11). Avoid excessive door opening and shut it as soon as possible.

4.5 Insulation Cracking

The insulation material in this furnace is susceptible to surface cracking as a result of temperature cycling. This is a normal occurrence and such cracking is not detrimental to the performance of the overall life of the furnace, under normal operation.

4.6 Atmospheres & Corrosive Materials

In oxidising atmospheres, metal oxides react with the silica layer on the surface of the elements and may lead to premature failure. Protect the elements from splashes of molten metal and dust when loading the furnace and from fumes developed when melting, especially from fluxes. Also avoid compounds with a high alkali content.

The furnace is designed for use up to its maximum temperature in oxidising atmospheres, but can be operated successfully in neutral or carburising atmospheres.

It may be used with nitrogen, argon or helium atmospheres to 1600 °C. Reducing atmospheres are not recommended. Sulphur dioxide is not harmful in low concentrations. However chlorine and fluorine attacks oxidised elements and should be avoided. A harmful gas is produced and collects in poorly ventilated spaces.

The furnace is not recommended for burning off carbonaceous materials. Other Carbolite Gero furnaces are available for this application.

When an optional gas inlet is fitted there is a label near the inlet saying "INERT GAS ONLY".

The chamber is not gas tight, the gas usage may be high and the chamber is always likely to contain some air. Residual oxygen of approximately 1% to 2% is to be expected.

Periodically operate the furnace in air at 1500 °C for an hour to ensure the protective glaze on the elements surface is maintained.

The hearth can be protected from abrasion, if required, by the provision of a secondary plate. This consumable item can either be in lightweight ceramic fibre or in dense, hard-wearing alumina refractory.

4.7 Pesting

The furnace is fitted with molybdenum disilicide elements and is therefore susceptible to peesting. Pesting can be seen as a yellowish crystal growth on the surface of the element. It occurs when the element surface temperature is around 450 °C and is caused by the air oxidising with the molybdenum in the element compound. Under normal operating conditions (above 800 °C) peesting is not a problem and can often be seen occurring naturally on the element terminals.

operating the furnace for prolonged periods at temperature below 600 °C will cause peesting to occur on the element surface and will eventually damage the elements.

Heating on a slow ramp rate or dwelling at temperatures below 600 °C for short periods will not cause a problem providing the furnace is operated above 1400 °C at regular intervals to recondition the element surfaces.

Large amounts of peesting occurring on the element terminals must be removed in accordance with good health and safety practices.

4.8 Explosive Materials

The product must not be used to heat materials which could explode, or which could emit gases that could form explosive mixtures.

4.9 Notes on Temperature Control

This product is designed for heating and cooling at controlled rates. The heating and cooling rates can be set in the temperature programmer. The programmer enables the furnace to heat or cool at slower rates as desired and variable "hold" (dwell) periods can be programmed as required.

The programmer is used in conjunction with a phase angle thyristor power controller, which incorporates a current limit potentiometer pre-set by Carbolite Gero, but which will require adjustment in the event of change of supply voltage.

The elements are connected in series across the low voltage output of a transformer housed in the furnace case. Molybdenum disilicide elements do not age, if an element fails it is not necessary to replace the complete set.

4.10 Thermocouple Warnings

(1) The output from 1700-1800 °C thermocouples when used regularly at temperatures greater than 1650 °C can deteriorate and decrease with age faster than if used at temperatures below 1650 °C; this will cause the furnace to operate at temperatures higher than indicated.

Operators are advised to periodically check the thermocouple output, either by a calibration test or by comparing the output with a new reference thermocouple which has been subjected to high temperatures for a minimum length of time.

Failure to check the thermocouple regularly may result in overheating of the work and the furnace, with consequential damage to both.

(2) The thermocouples fitted to these models give very low outputs below approximately 600 °C and do not give accurate readings at low temperatures. They may show a negative temperature when the furnace is started from cold.

This furnace is not intended to operate with a setpoint below 600 °C.

4.11 Thermal Cutouts

There is a thermal cutout on the interior case surface at the centre top near the chimney. In the event of fan failure or any other reason for case over heating, power to the heating elements is cut.



To reset the thermal cutout, first isolate the furnace from the electrical supply. Remove the top panel and press upwards the button on the cutout device. TAKE CARE - the chimney may be hot.

There is a further thermal cutout in the element circuit transformer which cuts power if the transformer core overheats. This is self-resetting.



If either thermal cutout is activated, then a fault light on the control panel is illuminated.

4.12 General Operating Advice



Heating element life is shortened by overheating. Do not leave the product at high temperature when it is not required. The maximum temperature is shown on the product rating label and in section 10.0 towards the back of this manual.

When heating large objects, in particular poor conductors, avoid shielding the thermocouple from the heating elements. The thermocouple is intended to sense the temperature near the heating elements. However, if a large object is placed in the chamber it may record the average temperature of the object and the elements, this can lead to overheating of the elements. Allow large objects to gain heat at a lower temperature and then reset the controller to a temperature close to the desired maximum, or heat using a slowly controlled ramp rate. For more information refer to the controller instructions.

The product's elements are very susceptible to mechanical shock. Take great care when loading or unloading the chamber. If it is necessary to load or unload work at elevated temperatures, keep the door open for as short a period as possible. The insulation cools quickly and may crack though thermal shock.

For improved insulation and element life it is recommended to heat and cool at a slow ramp rate e.g. 5 °C/minute, and to avoid opening the door at high temperatures.

On first installing the elements and on subsequent element replacement, operate the product at 1500 °C for an hour to create a protective glaze on the element surface.

5.0 Maintenance

5.1 General Maintenance

Preventive rather than reactive maintenance is recommended. The type and frequency depends on the product use; the following are recommended.















5.2 Maintenance Schedule

 CUSTOMER

 QUALIFIED PERSONNEL



DANGER! ELECTRIC SHOCK. Risk of fatal injury. Only electrically qualified personnel should attempt these maintenance procedures.

Maintenance Procedure	Method	Frequency				
		Daily	Weekly	Monthly	Bi-Annually	Annually
Safety						
Safety Switch Function	Set a safe temperature above ambient, and open the door to see if the heater light goes out					
Safety Switch Function	Electrical measurement 					
Over-Temperature Safety Circuit (if fitted)	Set an over-temperature setpoint lower than the displayed temperature and check for an over-temperature alarm as detailed in this manual					
Over-Temperature Safety Circuit (if fitted)	Electrical measurement 					
Door Plug	Visual inspection, checking the seal and whether it is free of damage					
Door Plug	Replacement where necessary					
Chimney / Extraction	Check and clean if necessary					
Electrical Safety (external)	Visual check of external cables and plugs					
Electrical Safety (internal)	Physically check all connections and cleaning of the power plate area					
Function						
Temperature Calibration	Tested using certified equipment, frequency dependent on the standard required					

Operational Check	Check that all functions are working normally					
Operational Check	Thorough inspection and report incorporating a test of all functions					6
Performance						
Element Circuit	Electrical measurement 					6
Power Consumption	Measure the current drawn on each phase / circuit					6
Hearth	Visual check for fit and damage					
Cooling Fans (if fitted)	Check whether the cooling fans are working					

5.2.1 Cleaning

Soot deposits may form inside the furnace, depending on the process. At appropriate intervals remove these by heating as indicated in the General Operation Notes.



The product's outer surface may be cleaned with a damp cloth. Do not allow water to enter the interior of the case or chamber. Do not clean with organic solvents.

5.3 Safety Switch

When correctly functioning, the safety switch will isolate all live conductors (live and neutral connections) within the heating element circuit(s) when the product door is opened. The safety switch should be checked regularly to ensure that this occurs.

The safety switch should not fail under normal working conditions, however rough handling, exposure to corrosive materials/ environments, or exceptionally frequent use, could compromise the safety system.

Weekly check:

The following check can be carried out by a general operator:

- On the temperature controller, set a safe temperature above ambient. The heater lights should illuminate.
- Open the door and check the heater lights. They should no longer be illuminated.

If the heater lights remain illuminated when the door is open, discontinue use and contact Carbolite Gero Service.

Annual check:

The following checks should be carried out by a qualified electrician, as specified in the "Maintenance Schedule" section of this manual:

- Remove the element access panel and take a voltage measurement from the heating element terminals. Do not attempt to take a reading from the heating element itself as surface oxidation will give an unreliable contact.
- Ensure that power to the heating elements is switched off when the door is opened.

Contact Carbolite Gero Service and discontinue use of the product if it is found that the heating elements are not fully isolated during these checks.

5.3.1 Other Electrical Components

Regular visual or electrical checks should be made on the condition of the electrical supply cable. All internal fuses and visible internal cables should be inspected periodically.

5.3.2 Element Glaze

Depending on the use, heating elements may lose their glaze and gain a rough appearance. They should be checked from time to time. If the glaze has disappeared, it may be restored by heating the furnace up to 1500 °C, without load, for approximately 2 hours.

5.4 Calibration

After prolonged use, the controller and/or thermocouple may require recalibration. This is important for processes that require accurate temperature readings or for those that use the product close to its maximum temperature. A quick check using an independent thermocouple and temperature indicator should be made from time to time to determine whether full calibration is required. Carbolite Gero can supply these items.

Depending on the controller fitted, the controller instructions may contain calibration instructions.

5.5 After-Sales Service

Carbolite Gero Service has a team of Service Engineers who can offer repair, calibration and preventive maintenance of furnace and oven products both at the Carbolite Gero factory and at customers' premises throughout the world. A telephone call or email often enables a fault to be diagnosed and the necessary parts to be despatched.

In all correspondence please quote the serial number and model type given on the rating label of the product. The serial number and model type are also given on the back of this manual when supplied with the product.

Carbolite Gero Service and Carbolite Gero contact information can be found on the back page of this manual.

5.6 Recommended Spare Parts and Spare Parts Kit

Carbolite Gero can supply individual spare parts or a kit of the items most likely to be required. Ordering a kit in advance can save time in the event of a breakdown.

Each kit consists of one thermocouple, one sheath, one power thyristor, one door insulation piece and a set of elements, clips and braids, element clamps and insulators. Individual spare parts are also available.

When ordering spare parts please quote the model details as requested above.

5.7 Power Adjustment (Controller)

The product's controller incorporates a power limit parameter OP.Hi, which is usually inaccessible to the operator.

The correct setting for the power limit depends on the supply voltage, table given in section 9.0

5.8 Power Adjustment (Thyristor)

The current-limiting thyristor stacks which control power to the elements are fitted with an adjustable resistor which is factory set to limit the maximum current supplied. In the event of a change of supply voltage, or the fitting of a new thyristor, further adjustment may be required.

The maximum element currents for this model are listed in section 9.0. Please contact Carbolite Gero for further information.

5.9 Low Voltage Compensation

If the supply voltage proves to be routinely below the nominal figure for which the furnace has been set up, there is a "+2%" position on the transformer primary side which may be used instead of the standard position, see section 6.11.

6.0 Repairs and Replacements

6.1 Safety Warning - Disconnection from Power Supply



Immediately switch the product off in the event of unforeseen circumstances (e.g. large amount of smoke). Allow the product to return to room temperature before inspection.



Always ensure that the product is disconnected from the electrical supply before repair work is carried out.

Caution: Double pole/neutral fusing may be used in this product.

6.2 Safety Warning - Refractory Fibre Insulation



Insulation made from High Temperature Insulation Wool Refractory Ceramic Fibre, better known as (Alumina silicate wool - ASW).

This product contains **alumino silicate wool** products in its thermal insulation. These materials may be in the form of blanket or felt, formed board or shapes, slab or loose fill wool.

Typical use does not result in any significant level of airborne dust from these materials, but much higher levels may be encountered during maintenance or repair.

Whilst there is no evidence of any long term health hazards, it is strongly recommended that safety precautions are taken whenever the materials are handled.

Exposure to fibre dust may cause respiratory disease.

When handling the material, always use approved respiratory protection equipment (RPE-eg. FFP3), eye protection, gloves and long sleeved clothing.

Avoid breaking up waste material. Dispose of waste in sealed containers.

After handling, rinse exposed skin with water before washing gently with soap (not detergent). Wash work clothing separately.

Before commencing any major repairs it is recommended to make reference to the European Association representing the High Temperature Insulation Wool industry (www.ecfia.eu).

Further information can be provided on request. Alternatively, Carbolite Gero Service can quote for any repairs to be carried out either on site or at the Carbolite Gero factory.

6.3 Safety Warning - Molybdenum Disilicide Elements



Molybdenum disilicide elements form a glazed surface when heated. Internal stresses can form through heating and cooling which render the glaze fragile. The glaze can sometimes splinter into a shower of sharp particles when handled. Always wear eye protection when handling the elements.

Handle the heating elements with extreme care as they are very fragile. Also, avoid touching the heating surface (the thin part of the element), as the material is susceptible to corrosive damage from skin contact.

6.4 Side Panel Removal



Except where explicitly stated, always disconnect the electrical supply before removing the side panel.

Remove the panel by loosening the four fixing screws (behind plastic caps) at the left-hand end of the furnace; do not remove the screws. Lift the panel about 15 mm and then pull off to the side.

6.5 Thyristor Replacement and Adjustment

Replacement

To replace the thyristor unit, isolate the furnace from the electrical supply and remove the left-hand side cover. See section 6.4. Make a note of all wiring to the thyristor, then disconnect it. Replace the unit and connect the wiring again.

Note that the thyristor unit requires replacement if changing from, or to, a 208 V supply.

If the thyristor unit has been replaced because of a change of voltage, the correct transformer tapping should also be set. See section 6.11 for panel removal instructions.

Adjustment

After any thyristor unit replacement, or any change of voltage or transformer tapping, the potentiometer on the thyristor must be adjusted to give the correct element current. This should be done by a qualified person, as there are dangerous voltages inside the control compartment. It also requires a calibrated non-intrusive clip-on ammeter.

Before connecting the electrical supply, turn the potentiometer on the thyristor fully to the left (anti-clockwise). This sets the output current of the thyristor to 'off'.

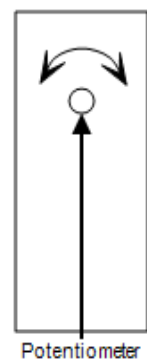

Connect the electrical supply with the side cover off. TAKE CARE! Set the furnace temperature to maximum. Allow the furnace to start heating up.

Measure the current through the element circuit. This is carried out with the clip-on meter around one pair of thick cables on the left-hand side of the transformer (as seen when facing the control side of the furnace).

Adjust the potentiometer on the face of the thyristor unit. Adjust it slowly to the right (clockwise) to increase the current, pausing to allow the time for response at the meter. Keep adjusting to obtain an ammeter reading of between 149 to 150 A for the HTF 1700 or 139 to 140 A for the HTF 1800. This adjustment should be set up within the first 5 minutes of heat up from ambient and should finally be checked when the furnace temperature is approximately 100 °C below its maximum temperature. Make further adjustments if necessary at this temperature.

Disconnect the electrical supply to ensure safe replacement of the side panel. See section 6.1

6.6 Temperature Controller Replacement

Refer to the controller instructions for more information on how to replace the temperature controller.

6.7 Fuse Replacement

Access to internal fuses is by removal of the furnace side cover (see section 6.4). See section 9.0 for details of fuses fitted.

6.8 Thermocouple Replacement

Disconnect the product from the supply and remove the product's element access panel.

Make a note of the thermocouple connections. The negative leg of the thermocouple is marked blue. The "compensating" cable for 1700 & 1800 °C thermocouples is plain copper.

Disconnect the thermocouple from its terminal block.

Undo the screw to release the thermocouple sheath; withdraw the sheath and shake out any fragments of thermocouple.

Re-assemble with a new thermocouple observing the colour coding. Ensure that the thermocouple is not twisted as it is being inserted and that the metal tag is bent back, or the screw inserted, to grip the sheath.

6.9 Element Installation and Replacement



See section 6.2 - wearing a face mask is required.



See section 6.3 - Safety Warning - molybdenum disilicide.



Molybdenum disilicide elements form a glazed surface when heated. Internal stresses can form through heating and cooling which render the glaze fragile. The glaze can sometimes splinter into a shower of sharp particles when handled. Always wear eye protection when handling the elements.

Handle the heating elements with extreme care as they are very fragile. Also, avoid touching the heating surface (the thin part of the element), as the material is susceptible to corrosive damage from skin contact.

Initial Installation:

The elements, clips and braids are packed separately. Handle them carefully while unpacking.

Fit the insulation blocks to the elements. Locate the clamps over the elements and tighten carefully. The length of element above the fixing clamps should be as follows:

1700 °C models: 42 mm

1800 °C models: 45 mm

Lower the elements into position and connect the braids according to the scheme shown below using the clip tool provided. The braids must be held tightly to the element as the clips are fitted:

good contact is essential; poor contact can lead to sparking and destruction of the top of the element.

Ensure that the elements are correctly placed: the thin part of the element, and the tapered section, should ideally be within the heating chamber. The element should not touch the bottom of the chamber.

Important -There should be a minimum clearance of 10 mm below the bottom of the element, and a minimum clearance of 15 mm from the sides of the chamber. The elements should be parallel with the side walls.

Replacements:

Read the section above on initial installation.

Remove the aluminium braids and clips using the clip tool provided with the furnace. Lift out the old elements and the insulation blocks: handle the insulation pieces with care as they are fragile.

Carefully loosen and remove the clamps.

Prepare and install the new elements as explained above.

Heat up the furnace to a moderate temperature and ensure that the furnace is controlling properly, in case the previous element failure resulted from a fault in the control system.

After installing new elements, run the furnace at 1500 °C for an hour. This creates a protective glaze on the element surface.

Element Fitting Layout

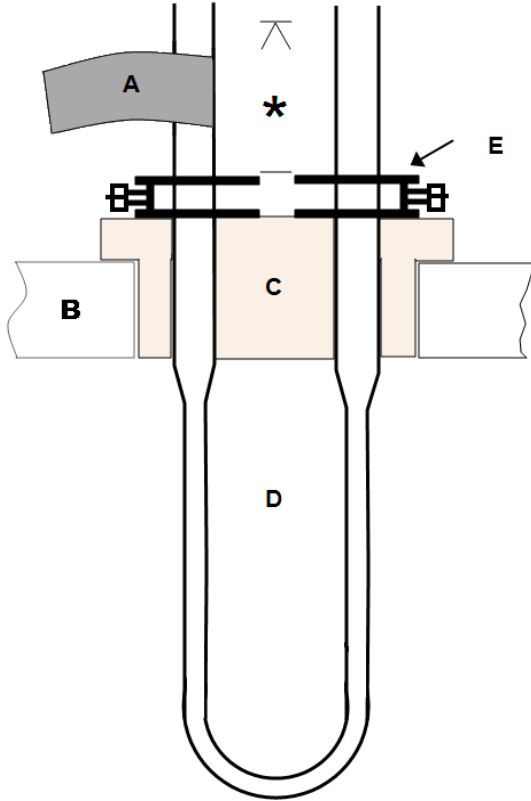

Use of Clip Tool

The tool comprises two levers

1. Clip tool
2. Apply hand pressure

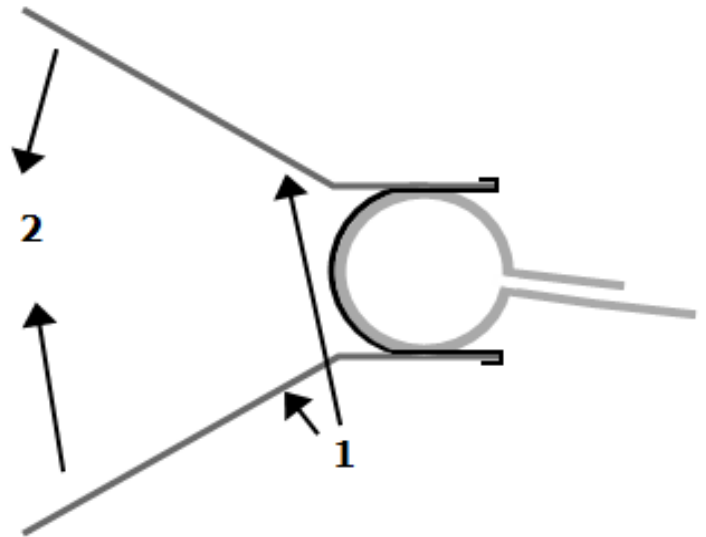

Key	
A	Braid
B	Roof Insulation
C	Element block
D	Element
E	Element Clamp
*	See text

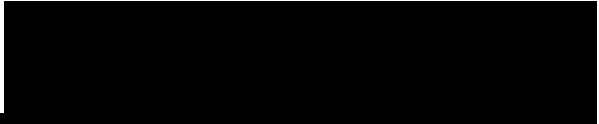

Element Connections - 4 Elements

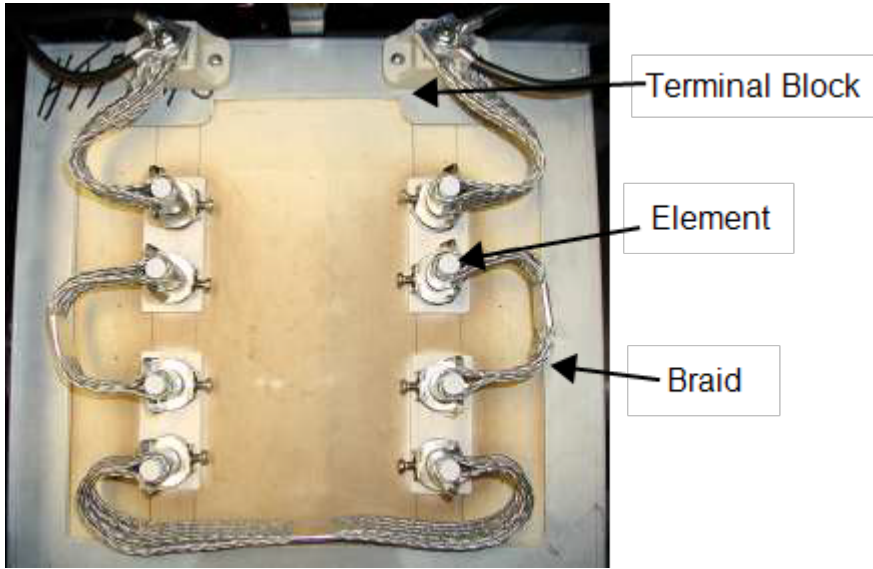

6.10 Insulation Replacement



See section 6.2 - wearing a face mask is required.

After any replacement of insulation material, run the furnace at 1500 °C to burn off volatile matter. Do this in a well ventilated area. Try to ensure that there is some chamber ventilation, but not too much as this could result in cracked insulation.

6.11 Transformer Tappings

A change of transformer tapping is required if the electrical supply voltage differs from the present setting.

To access the transformer tappings, first disconnect the furnace from the electrical supply and then remove the left-hand side cover (see section 6.4). Positions below are given from a viewing position at the left end of the furnace.

On the left side are the secondary tappings, which should not require change, but can be checked against the following data:

HTF 17/5	27 V
HTF 17/10	38 V
HTF 18/4	31.1 V
HTF 18/8	43.8 V

On the right side is a terminal strip with the following connections (208 to 240 V version shown).

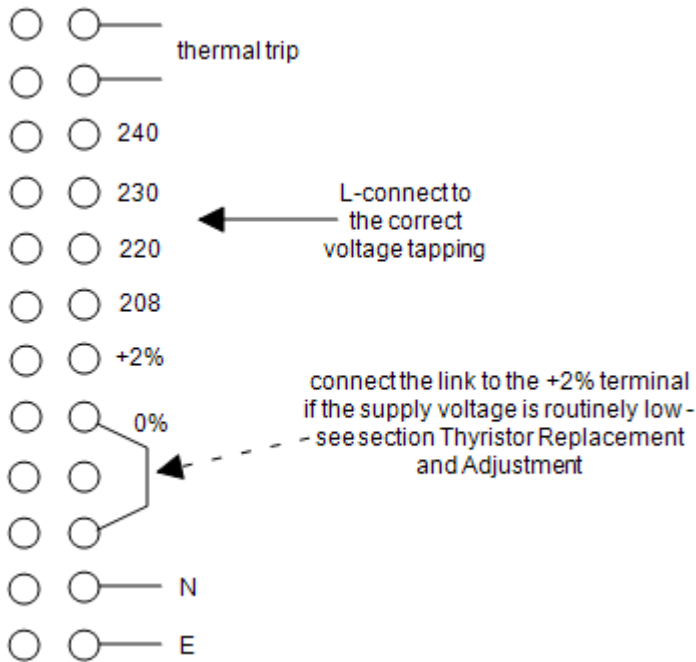

In the case of the 380-415 V version, there are three tappings marked 380, 400 and 415.

The thermal trip connection forms part of the circuit to the contactor coil.

The L and N connection may alternatively be L1 and L2 for a live-to-live supply. The L side should be connected to the correct tapping to match the electrical supply voltage.

The link wire should be in position as shown unless the electrical supply voltage is always low, in which case there is the option of moving one end to the +2% terminal.

Important - Changing the transformer primary tapping (including the +2%) requires adjustment of the thyristor current - see section 6.5.

The terminal between the link connection is not used.

6.12 Fuse Replacement

Fuses are accessed by removal of the appropriate panel, as described in the 'Panel Removal' section. Depending on the model, supply fuses and control circuit fuses may be mounted in their own holders, or may be on a circuit board that contains an EMC filter. The fuses are marked with their ratings.

Take care not to disconnect the wires leading from the EMC filter without first recording their positions: they must be reconnected to the correct terminals.

Note: The main fuses for PF 30 models are located in an external fuse holder positioned next to the IEC socket for the power supply cable.

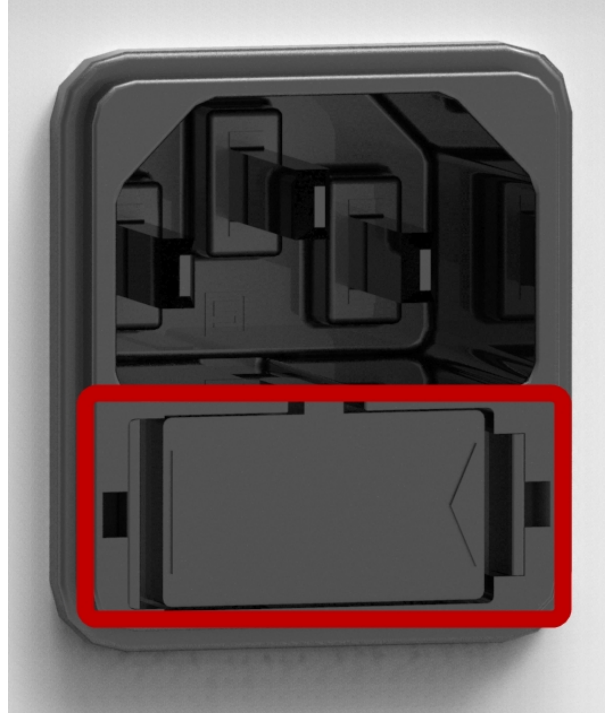

7.0 Fault Analysis

A. Furnace Does Not Heat Up					
1.	The HEAT light(s) are ON.	▶	An ohm meter applied to the element circuit shows an open circuit.	▶	A heating element has failed.
2.	The HEAT light(s) are OFF.	▶	The controller shows a very high temperature or a code such as S.br.	▶	The thermocouple has broken or has a wiring fault.
		▶	The controller shows a low temperature.	▶	The door switch may be faulty or need adjustment.
				▶	The thyristor fuse may have blown.
				▶	The power thyristor could be failing to switch on due to internal failure, faulty wiring from the controller, or fault controller.
		▶	There are no lights glowing on the controller.	▶	Check the supply fuses and any fuses in the product control compartment.
				▶	The controller may be faulty or not receiving a supply due to a faulty switch or a wiring fault.
		▶	The fault light on the control panel is on	▶	The thermal cutout on the case or in the transformer has activated.

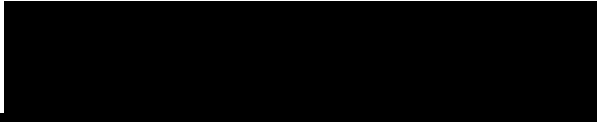

B. Product Overheats					
1.	The HEAT light goes OFF with the instrument switch.	▶	The controller shows a very high temperature.	▶	The controller is faulty.
		▶	The controller shows a low temperature.	▶	The thermocouple may have been shorted out or may have been moved out of the furnace.
				▶	The thermocouple may be connected the wrong way around.
				▶	The controller may be faulty.
2.	The HEAT light does not go off with the instrument switch and the fault persists when a 2 A control fuse is removed from its fuse-holder.	▶	The power thyristor has failed "ON".	▶	Check for an accidental wiring fault which could have overloaded the thyristor. <i>Isolate the furnace if this fault persists.</i>

8.0 Wiring Diagrams

8.1 Single Phase 208 V, 220-240 V

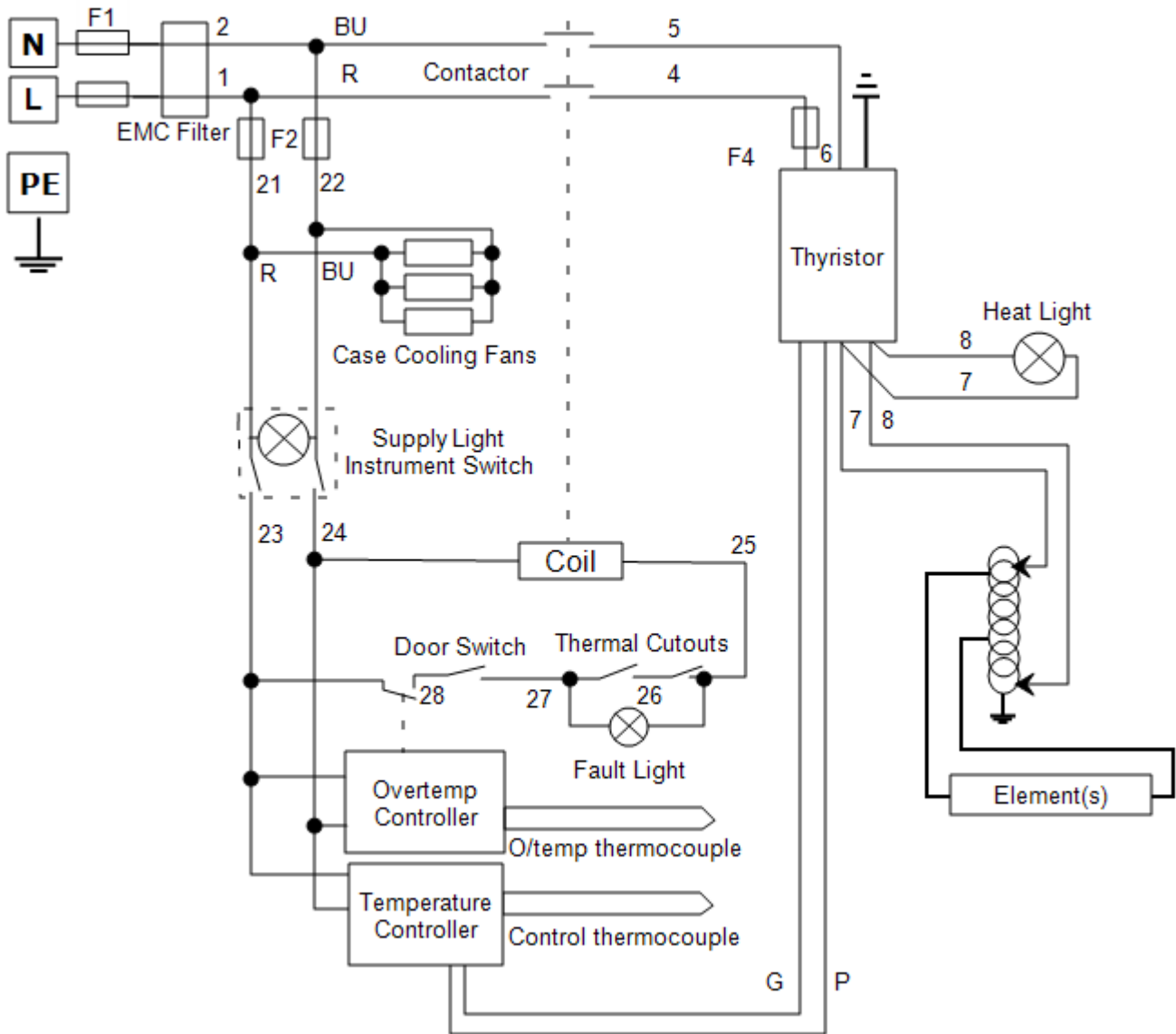

Thermal cutouts:

case temperature sensor

transformer temperature sensor

Wire colour:

BU	Blue
R	Red
P	Pink
G	Grey

GR/ Y

Green & Yellow

9.0 Fuses and Power Settings

9.1 Fuses

F1-F2: Refer to the circuit diagrams.

F1	Internal Supply Fuses	Fitted if supply cable fitted. Fitted on board to some types of EMC filter.	38 mm x 10 mm type F fitted on EMC filter circuit board(s)
----	-----------------------	--	--

F2	Auxiliary Circuit Fuses	Fitted on board to some types of EMC filter. May be omitted up to 25 Amp/phase supply rating.	2 Amps glass type F On board: 20 mm x 5 mm Other: 32 mm x 6 mm
----	-------------------------	--	--

	Thyristor Fuse		Ferraz Protistor of the rating shown
--	----------------	--	--------------------------------------

	Customer Fuses	Required if no supply cable fitted. Recommended if cable fitted.	See rating label for current; See table below for fuse rating.
--	----------------	---	---

Model	Phases	Volts	Supply Fuse Rating	Thyristor Fuse Rating	Current Limit (element circuit) [†]
HTF 17/5	1-phase	208	25 A	30 A	150 A
HTF 17/5	1-phase	220 -240	20 A	30 A	150 A

[†] see section 5.8 - the current limit setting at lower temperatures is 146 A.

9.2 Power Settings

The power limit settings (parameter OP.Hi) for this model are voltage dependant. The figures represent the maximum percentage of time that controlled power is supplied to the elements. Do not attempt to "improve performance" by setting a value higher than the recommended values. To adjust the parameter refer to the "Changing the Maximum Output Power" of the control section of the manual.

Volts (V)	208	220	230	240	380	400	415
Power (%)	100	100	100	100	100	100	100

Please refer to the rating label for product specific information.

10.0 Specifications

Carbolite Gero reserves the right to change the specification without notice.

Model	Max Temp (°C)	Max Power* (kW)	Chamber Size			Approx Capacity (l)	Max Load (kg)	Net Weight (kg)
			H	W	D			
HTF 17/5	1700	4.3	158	150	225	5.3	2.5	87

* Maximum power as measured, included ancillary components and transformer losses.

10.1 Environment

The models listed in this manual contain electrical parts and should be stored and used in indoor conditions as follows:

Temperature: 5 °C - 40 °C

Relative humidity: Maximum 80 % up to 31 °C decreasing linearly to 50 % at 40 °C

altitude:	not exceeding 2000 m
electrical supply:	fluctuation not exceeding 10%
overvoltage:	category II IEC60364-4-443
pollution:	degree 2

ProductLabel

The products covered in this manual are only a small part of the wide range of ovens, chamber furnaces and tube furnaces manufactured by Carbolite Gero for laboratory and industrial use. For further details of our standard or custom built products please contact us at the address below, or ask your nearest stockist.

For preventive maintenance, repair and calibration of all furnace and oven products, please contact:

Carbolite Gero Service

Telephone: + 44 (0) 1433 624242

Fax: +44 (0) 1433 624243

Email: ServiceUK@carbolite-gero.com

Carbolite Gero Ltd,

Parsons Lane, Hope, Hope Valley,
S33 6RB, England.

Telephone: + 44 (0) 1433 620011

Fax: + 44 (0) 1433 621198

Email: Info@carbolite-gero.com

www.carbolite-gero.com

CARBOLITE
GERO 30-3000°C

Copyright © 2021 Carbolite Gero Limited